

Perspektif üzerindeki harfleri görünüşlerdeki ilgili yüzeyler üzerine koyunuz.

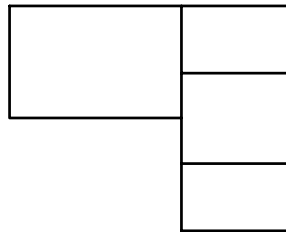

Çizen	Tarih	İsim	İmza	
Kontrol				
Ölçek				Resim nu.

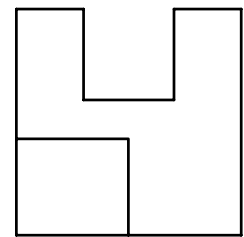
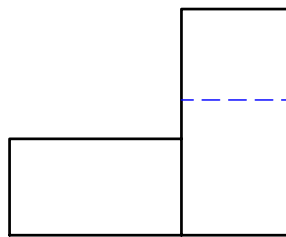
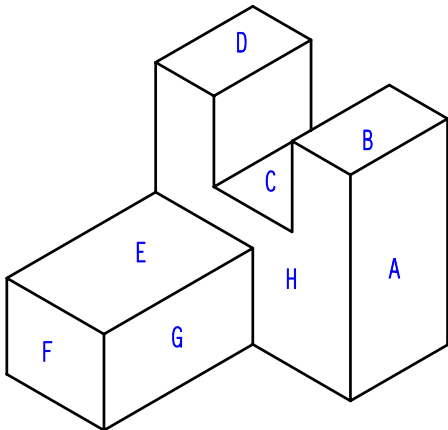
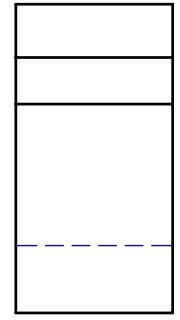
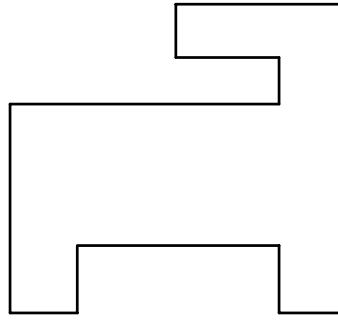
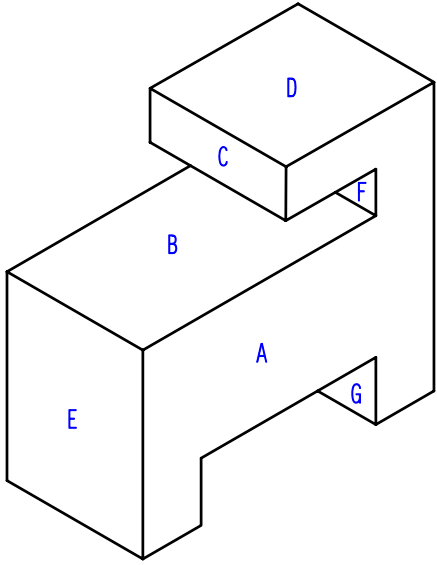
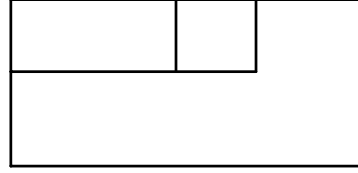
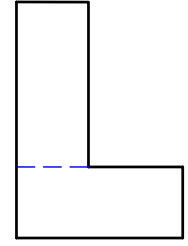
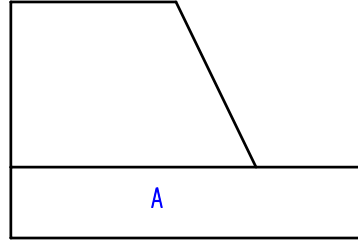
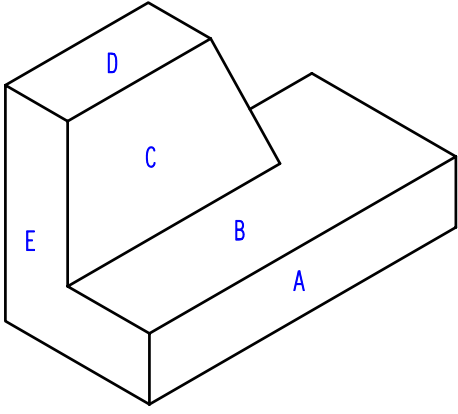

Verilen görünüşlerin hangi perspektife ait olduğunu çizelgeye yazınız.

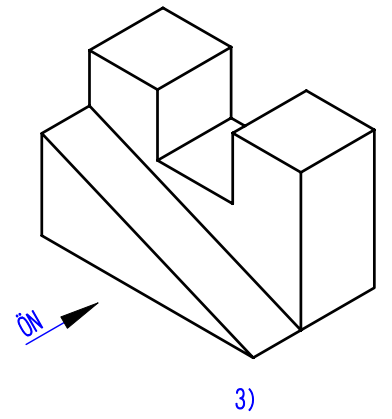
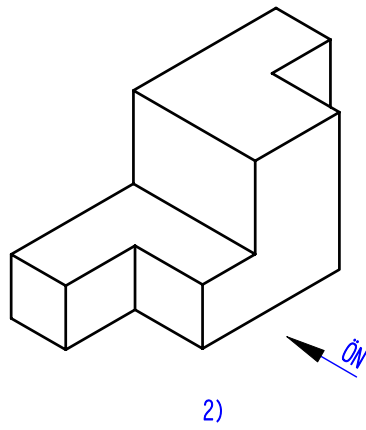
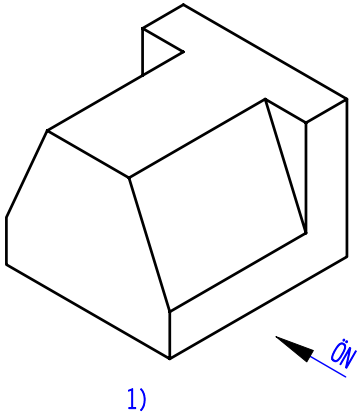

Ön görünüşler

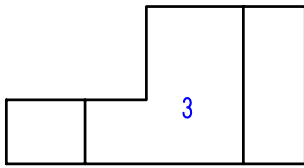
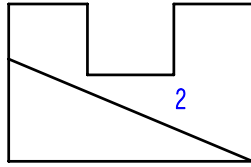
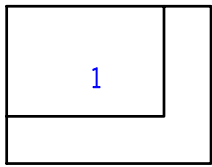

Sol yan görünüşler

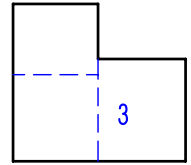
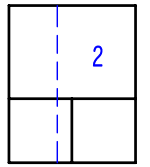
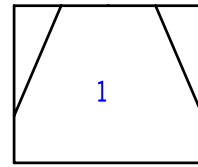

Üst görünüşler

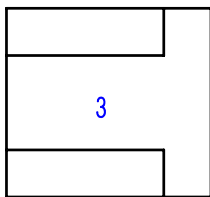
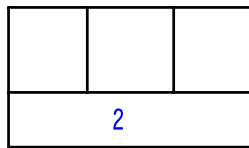
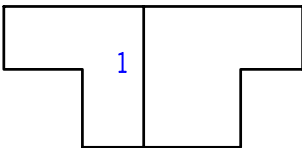

Perspektif nu.	1	2	3
Ön görünüş			
Sol yan görünüş			
Üst görünüş			

	Tarih	İsim	İmza	Resim nu.
Çizen				
Kontrol				
Ölçek				

Rakamlarla gösterilen ön, üst ve sol yan görünüşlerin hangi perspektife ait olduğunu altta verilen çizelgeye görüşlere ait rakamları yazınız.

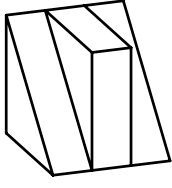

A

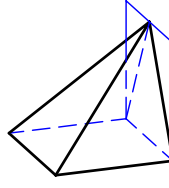

B

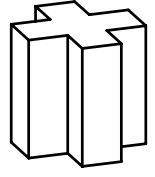

C

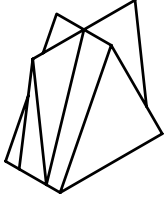

D

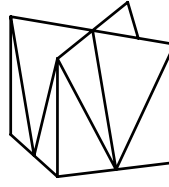

E

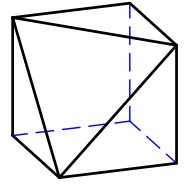

F

Ön görünüş

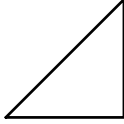

1

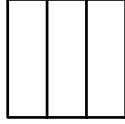

2

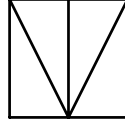

3

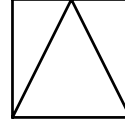

4

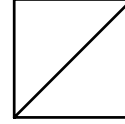

5

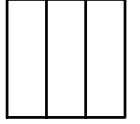

6

Sol yan görünüş



7



8



9

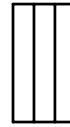

10



11



12

Üst görünüş

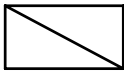

13

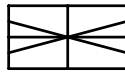

14

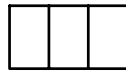

15

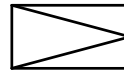

16

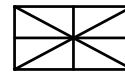

17

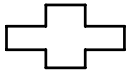

18

	A	B	C	D	E	F
ÖN						
YAN						
ÜST						

	Tarih	İsim	İmza	
Çizen				
Kontrol				
Ölçek				Resim nu.

Bakış doğrultusuna göre; perspektiflere ait önden görünüşleri işaretleyiniz.

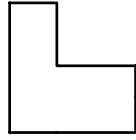
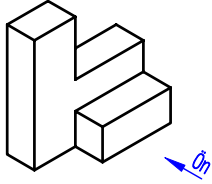

a

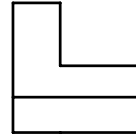

b

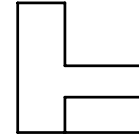

c

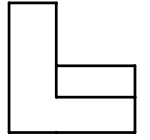

d

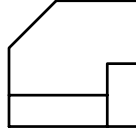
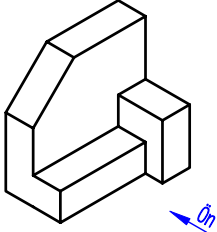

a

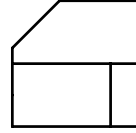

b

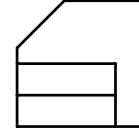

c

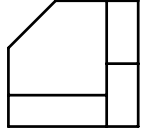

d

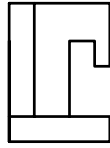
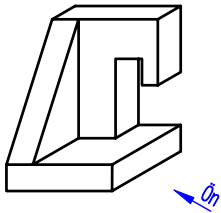

a

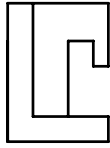

b

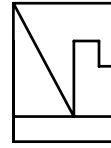

c

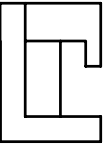

d

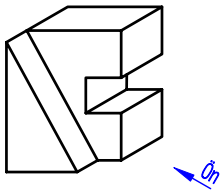

a

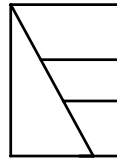

b

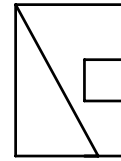

c

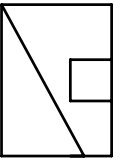

d

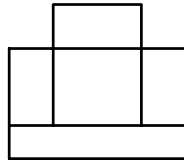
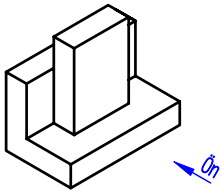

a

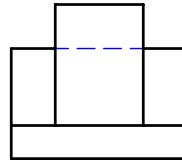

b

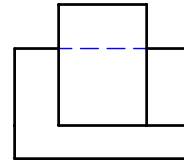

c

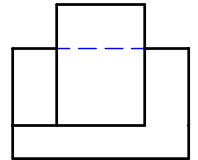

d

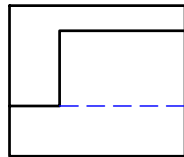
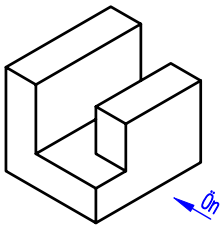

a

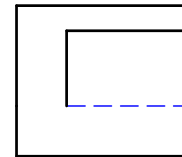

b

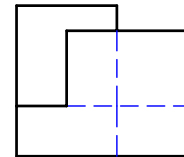

c

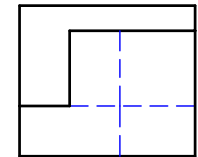

d

	Tarih	İsim	İmza	
Çizen				
Kontrol				
Ölçek				Resim nu.

İki görünüşü verilen perspektiflerin üçüncü görünüşünü çiziniz. Bazı görünüşlerdeki eksiklikleri tamamlayınız.
 Not: Ölçüler perspektiflerin üzerinden alınabilir.

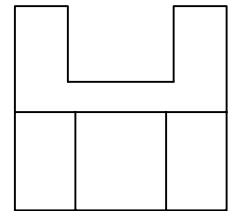
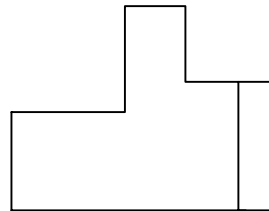
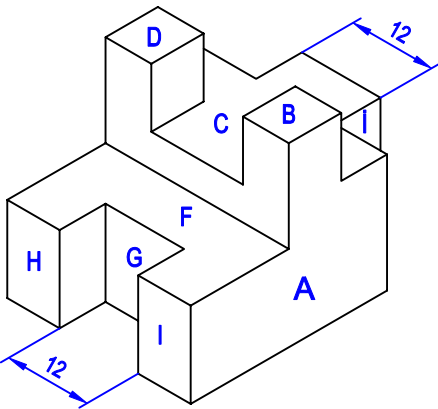
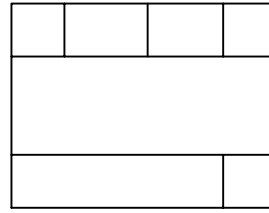
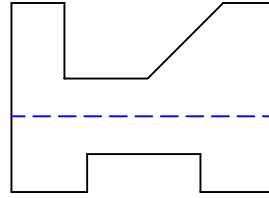
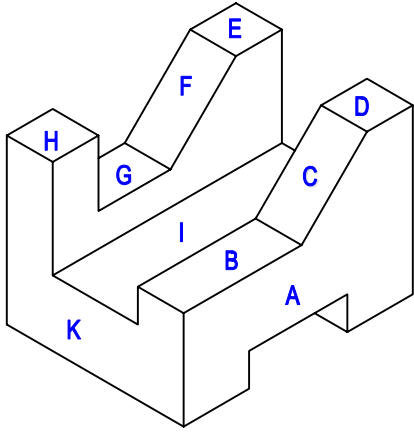
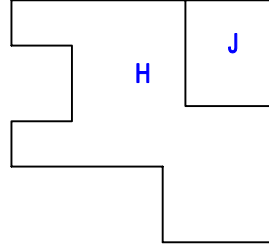
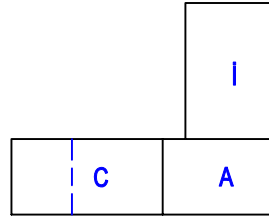
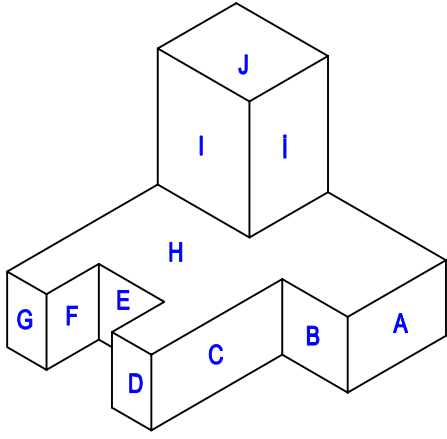

Üç görünüşü verilen perspektifin; diğer üç görünüşünü de çiziniz (D, E, F görünüşleri).
Not: Taşıma çizgilerini çiziniz.

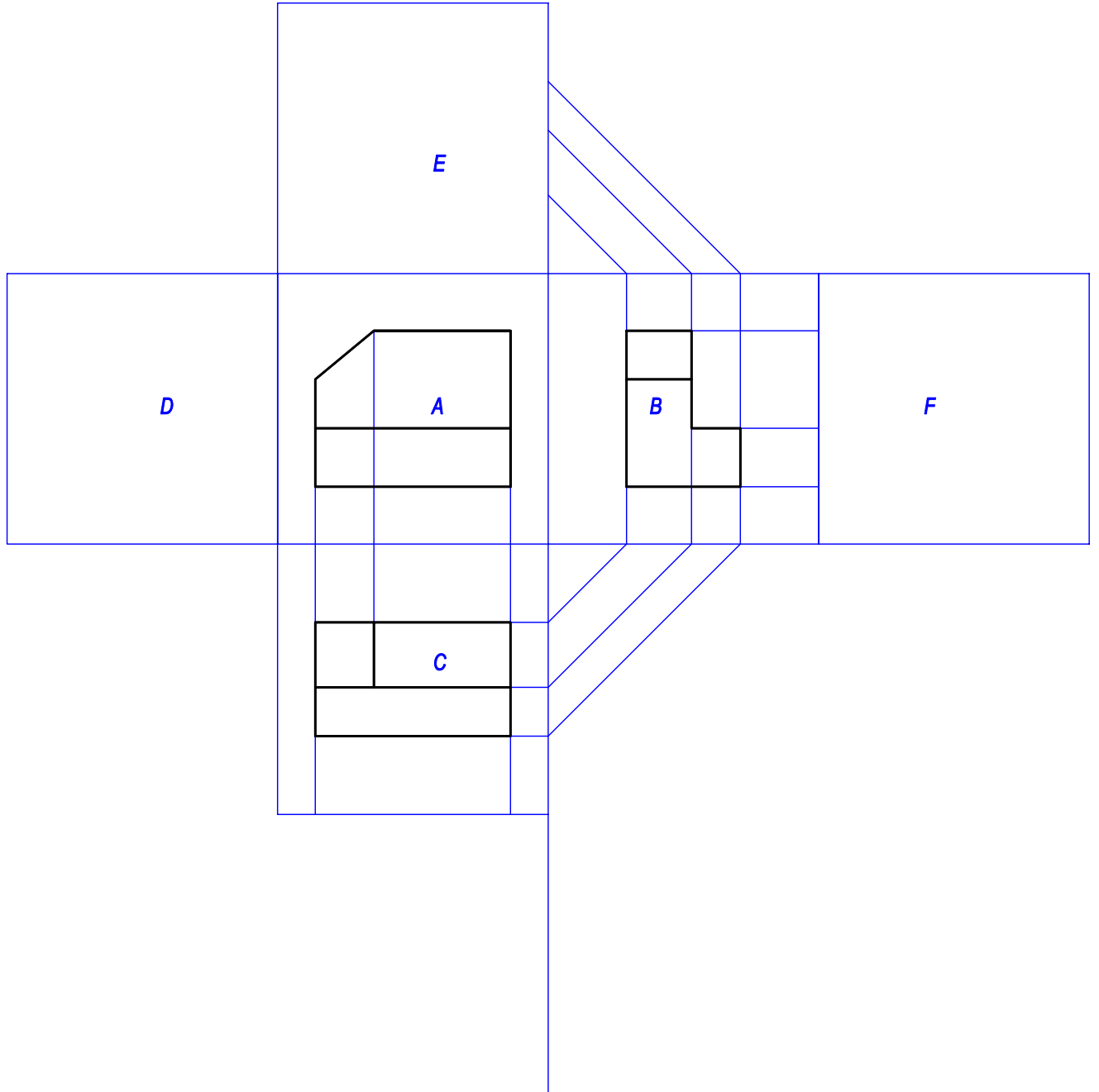
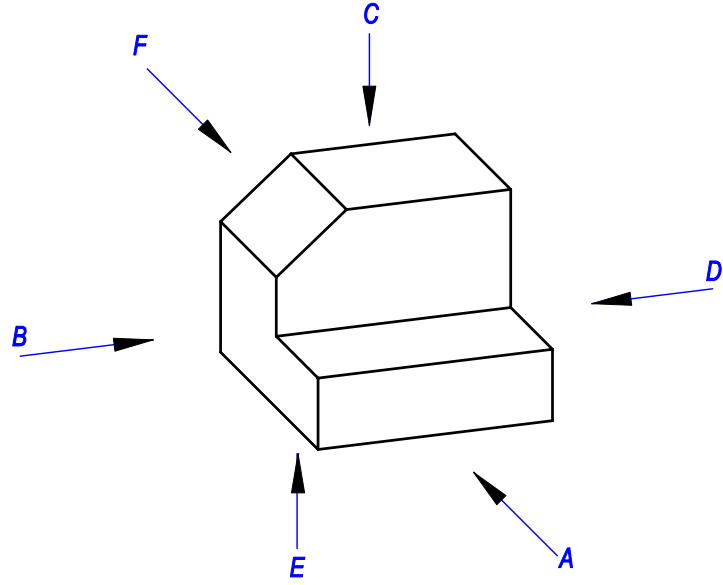

Her iki cismin üç görünüşünü çiziniz.

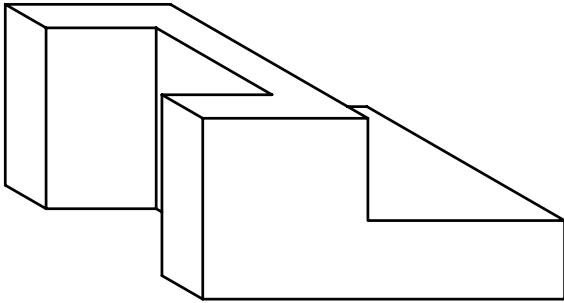
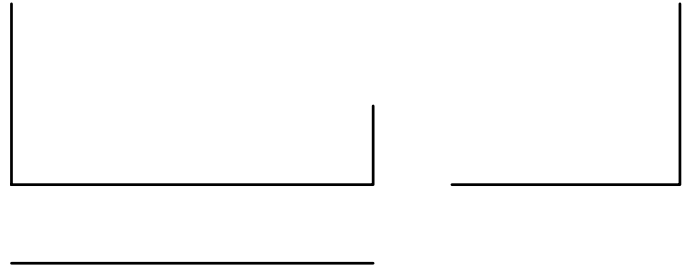
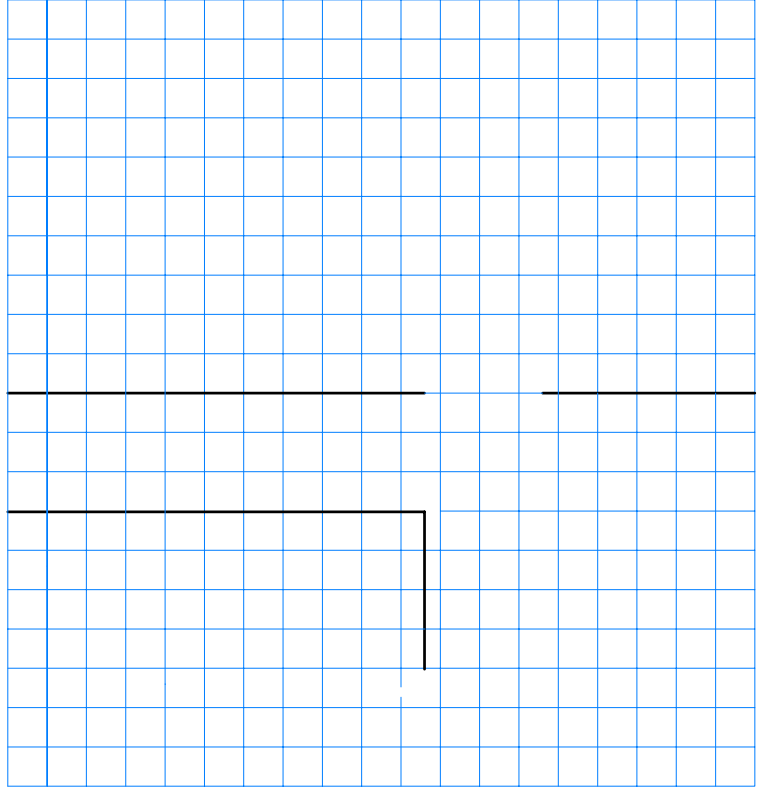
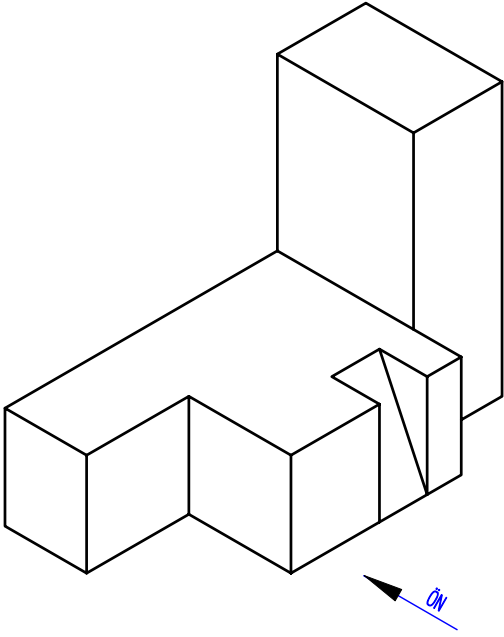

	Tarih	İsim	İmza	
Çizen				
Kontrol				
Ölçek				Resim nu.

Her iki cismin üç görünüşünü çiziniz (Ölçek 2:1, ölçüler resim üzerinden alınır).

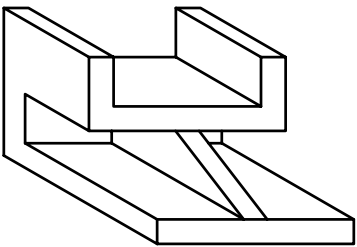
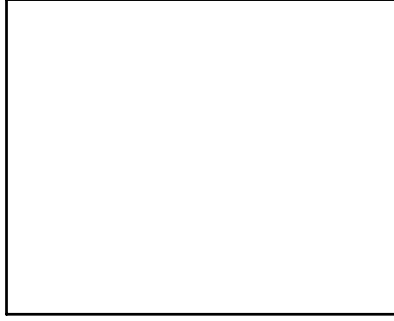
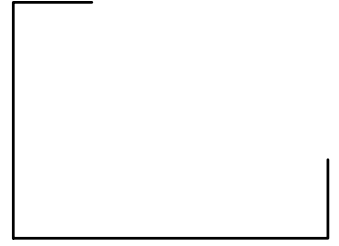
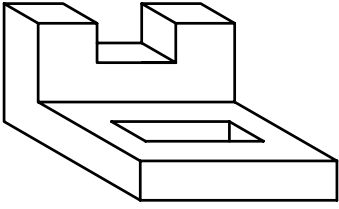

	Tarih	İsim	İmza	
Çizen				
Kontrol				
Ölçek				Resim no

Her iki cismin uç görünüşünü yan tarafına çiziniz.

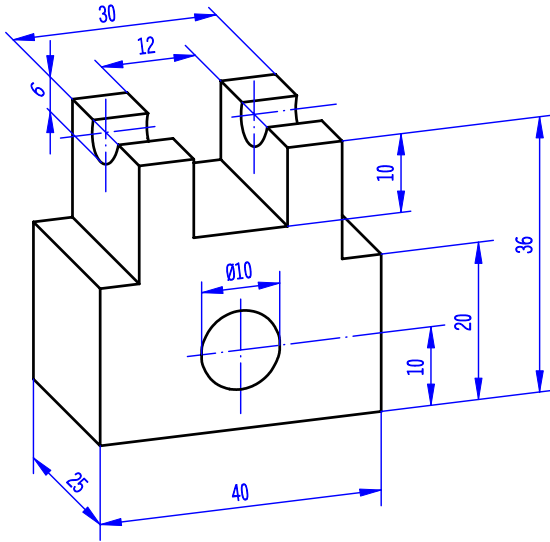
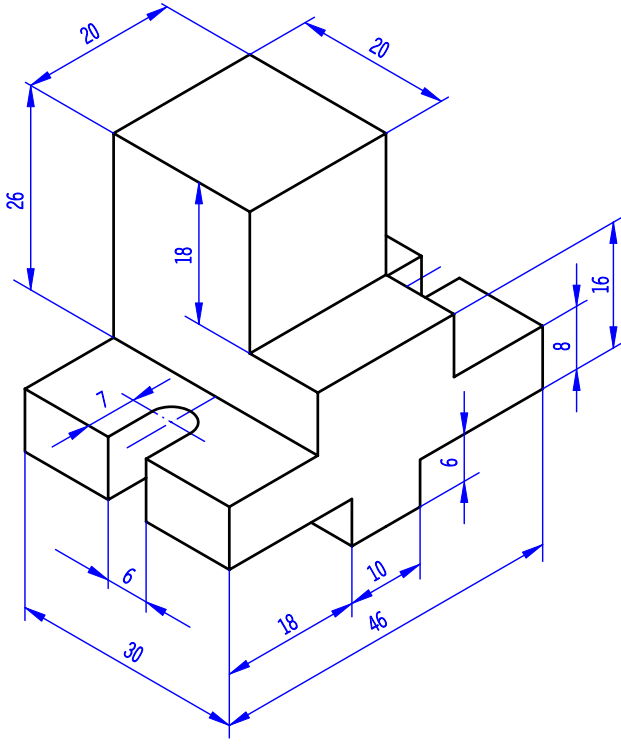

	Tarih	İsim	İmza	
Çizen				
Kontrol				
Ölçek				Resim nu.
				

Kesik silindirin örnek olarak çizilmiş görünüşleri

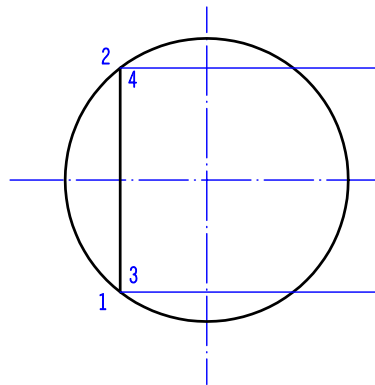
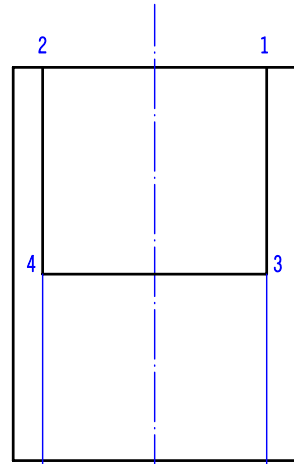
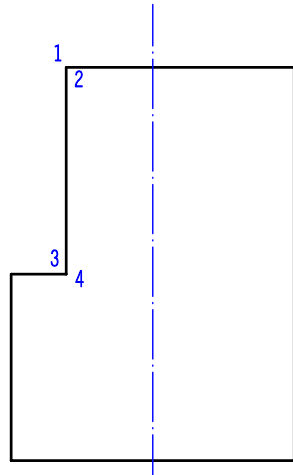
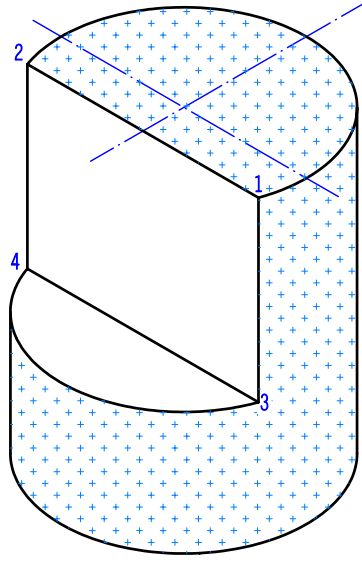

	Tarih	İsim	İmza	
Çizen				
Kontrol				
Ölçek				Resim nu.



Kesik silindirin uç görünüşünü çiziniz.

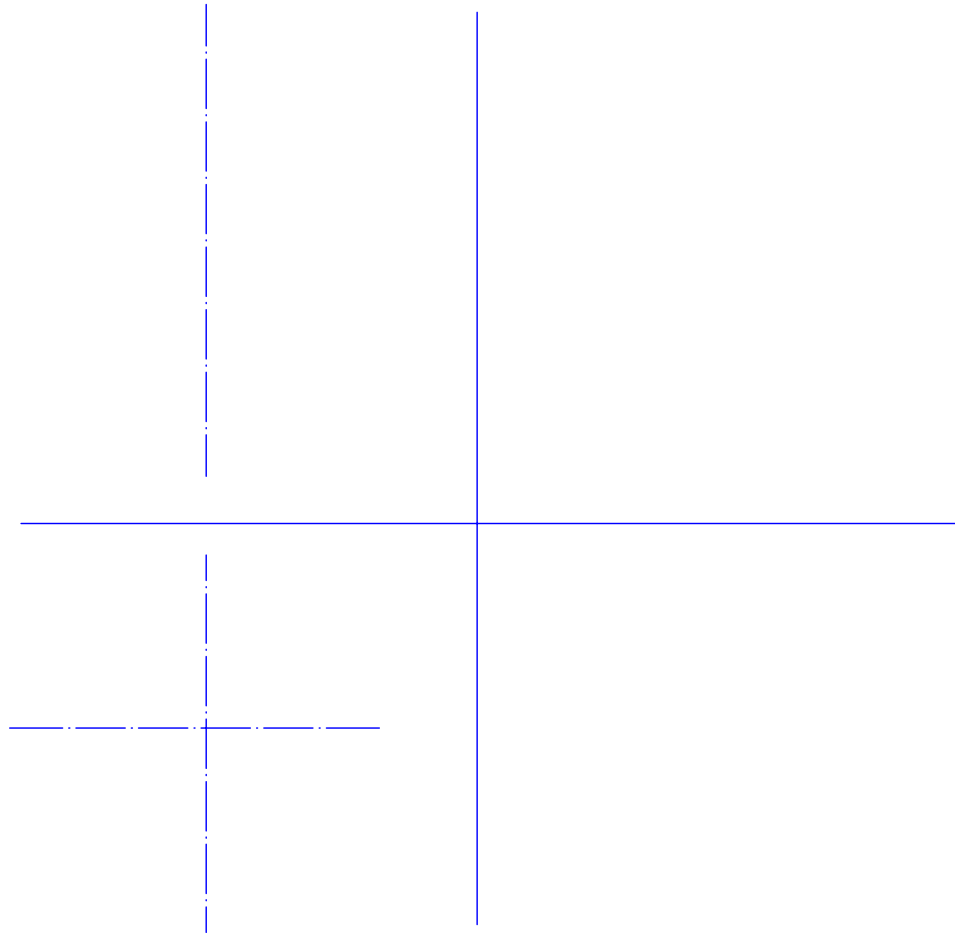
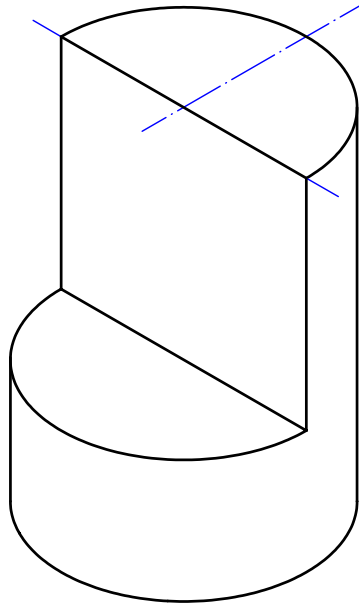

	Tarih	İsim	İmza	
Çizen				
Kontrol				
Ölçek				Resim nu.

Verilen perspektiflerin sol tarafına önden ve üstten görüşlerini 1:1 ölçekli, sağ tarafına ise sadece ön görüşlerini 2:1 ölçekli çizerek ölçülendiriniz.

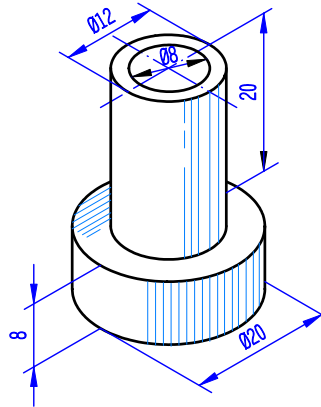
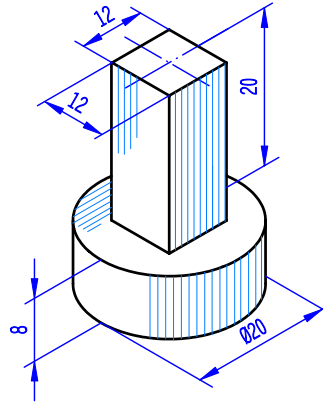
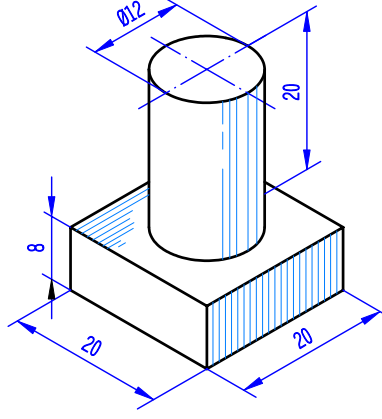

Cismin üç görünüşünü çiziniz.

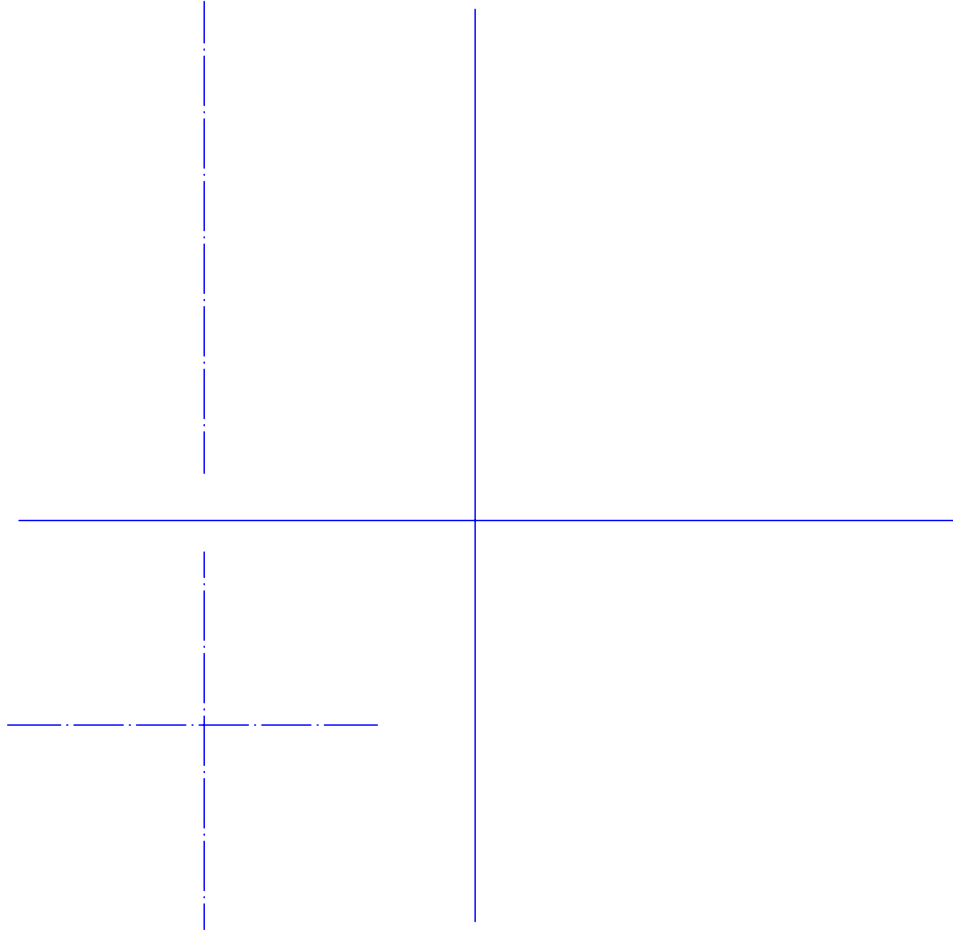
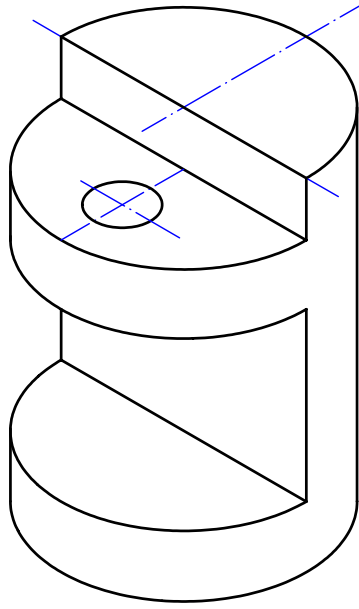

	Tarih	İsim	İmza	
Çizen				
Kontrol				
Ölçek				Resim nu.

Cismin üç görünüşünü çiziniz.

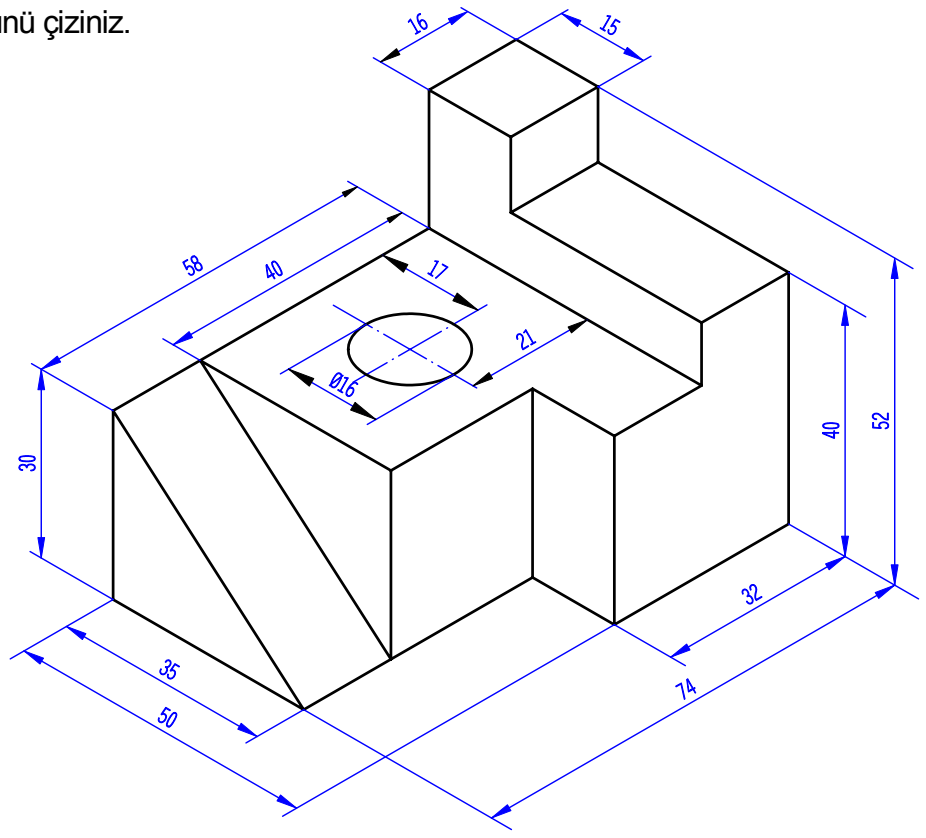

	Tarih	İsim	İmza	
Çizen				
Kontrol				
Ölçek				Resim nu.



Verilen görünüşleri inceleyiniz. Görünüşlere ait modelleri macun, patates, sabun gibi maddelerden yapınız. Perspektiflerini çiziniz (ölçüler resim üzerinden alınır).

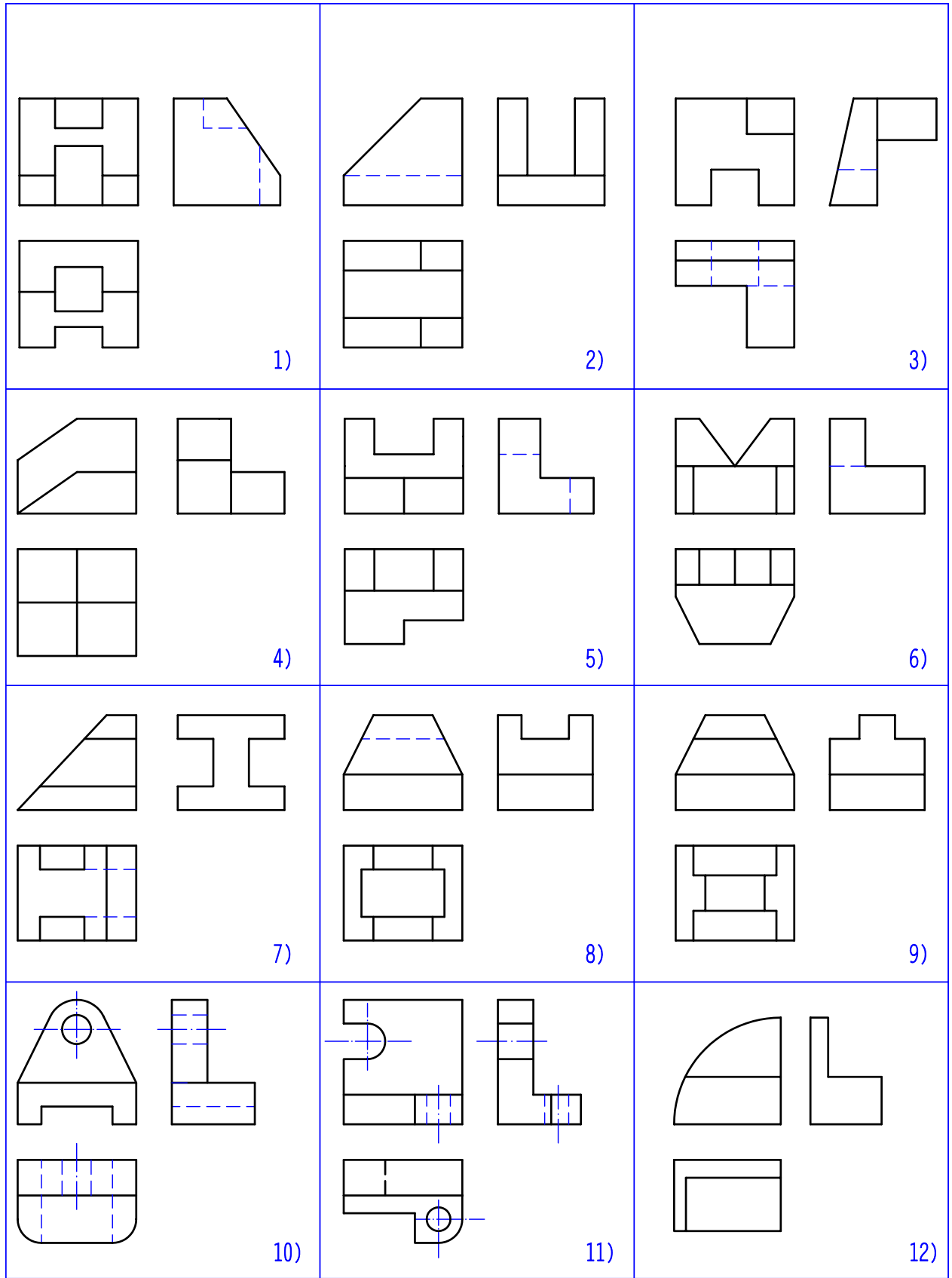

	Tarih	İsim	İmza	
Çizen				
Kontrol				
Ölçek				Resim nu.

İki görünüşü verilen parçaların üçüncü görünüşünü ve perspektifini çiziniz.

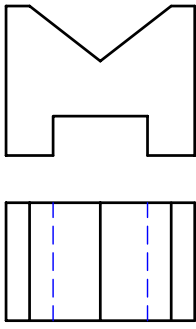
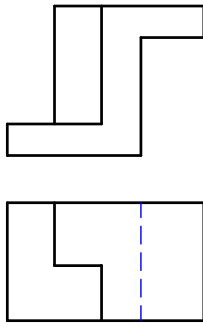
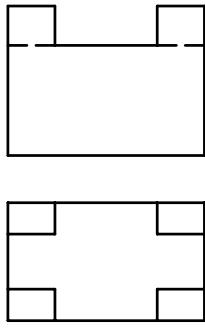
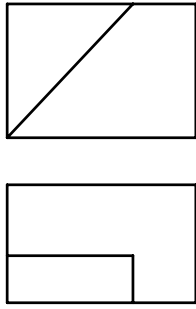
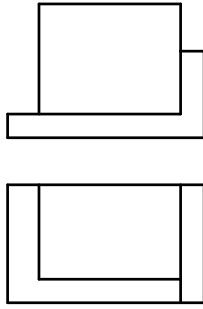
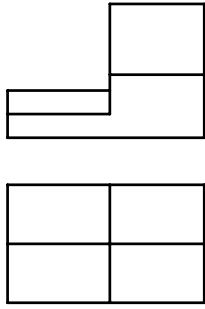
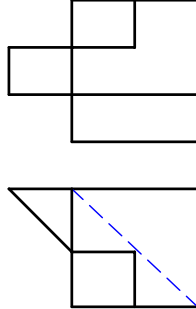
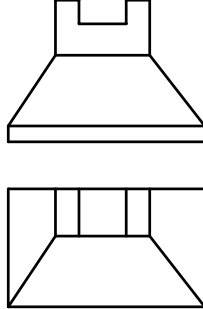
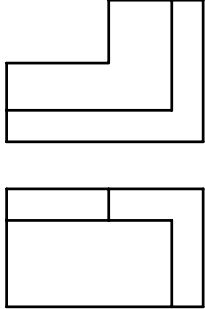
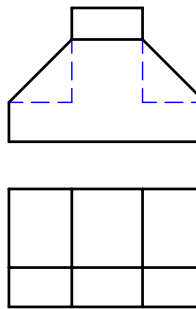
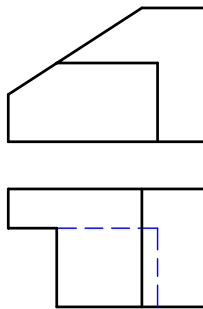
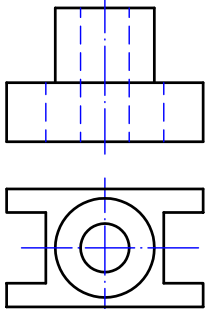
 <p>1)</p>	 <p>2)</p>	 <p>3)</p>
 <p>4)</p>	 <p>5)</p>	 <p>6)</p>
 <p>7)</p>	 <p>8)</p>	 <p>9)</p>
 <p>10)</p>	 <p>11)</p>	 <p>12)</p>

	Tarih	İsim	İmza	
Çizen				
Kontrol				
Ölçek				Resim nu.

Perspektifleri verilen parçaların üç görünüşlerini çiziniz (ölçüler resim üzerinden alınır.).

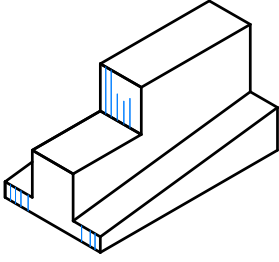
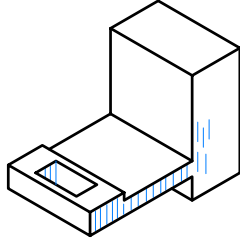
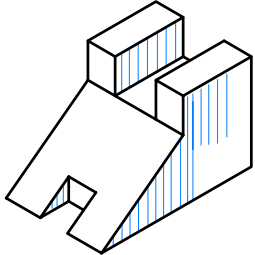
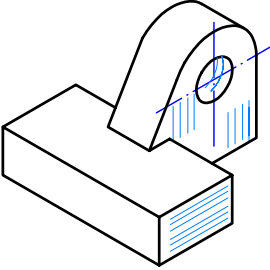
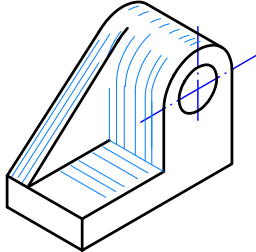
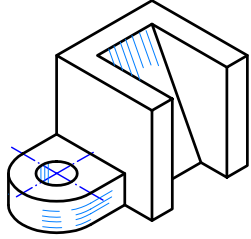
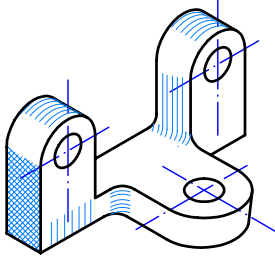
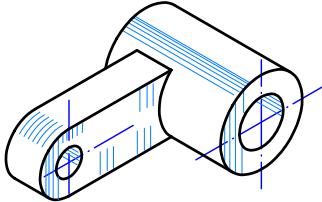
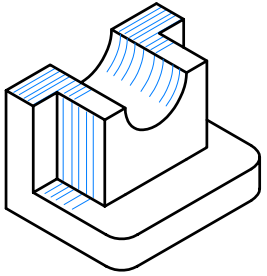
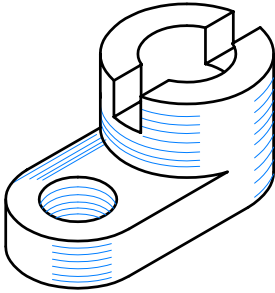
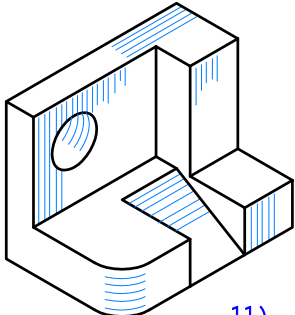
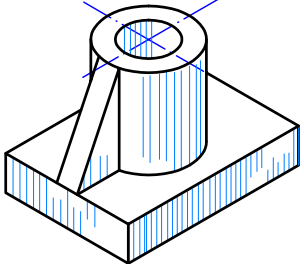
 <p>1)</p>	 <p>2)</p>	 <p>3)</p>
 <p>4)</p>	 <p>5)</p>	 <p>6)</p>
 <p>7)</p>	 <p>8)</p>	 <p>9)</p>
 <p>10)</p>	 <p>11)</p>	 <p>12)</p>

	Tarih	İsim	İmza	
Çizen				
Kontrol				
Ölçek				Resim nu.

Her uç cismin ön görünüşünü çizerek ölçülendiriniz.

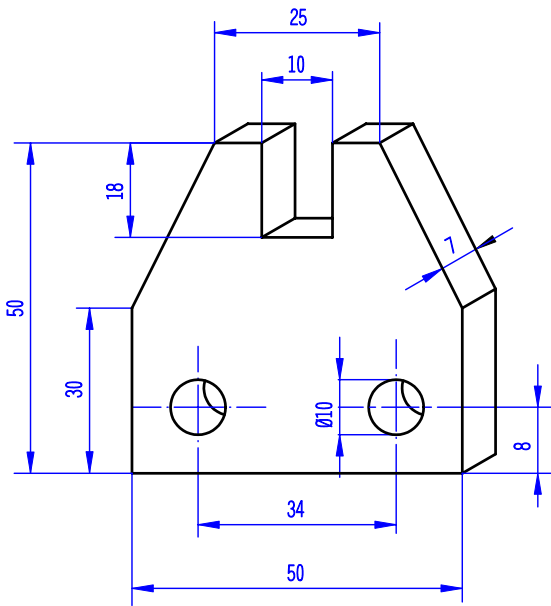
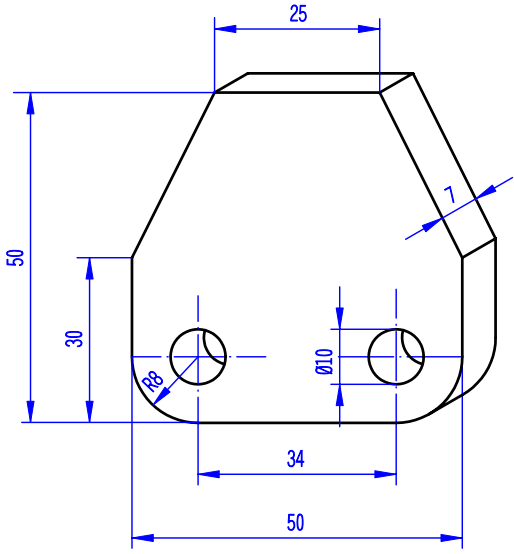
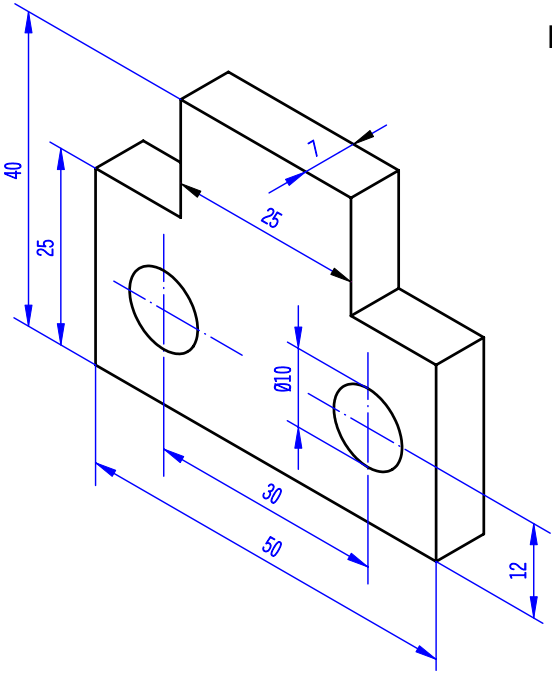

	Tarih	İsim	İmza	
Çizen				
Kontrol				
Ölçek				Resim nu.